

 PEGASUS[®]

EXT

EXT3200 : Variable top feed,
safety stitch machines
EXT5200 : Variable top feed,
overedgers



Makes them to highest quality

Top and bottom feed dogs on the variable top feed machines provide for positive and accurate fabric feed. This feature prevents twisting and plyshifting of the fabric being sewn, achieving high quality production.

These machines neatly perform shirring, piping and blindstitch hemming, operations that are difficult with bottom feeding alone, while preventing puckering. Pegasus' variable top feed machines ensure uniform quality during a wide variety of sewing operations.

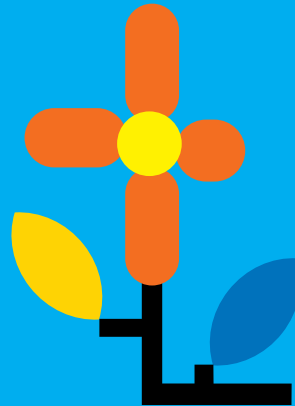

EXT Specifications in common

●Max. speed	7,000 rpm
●Stitch length	Max.5.0mm
●Overedge width	3mm - 8mm
●Presser foot lift	Up to 8mm
●Differential feed ratio	0.7mm - 3.8mm
●Top feed dog movement amount	1mm - 8mm

Note) The details of the specs. vary by subclass.

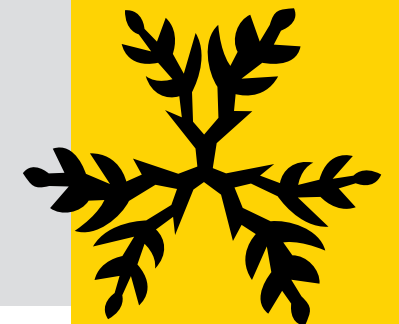

Point 1 High quality products with no twisting or plyshifting achieved by top and bottom feeding

Variable top feed machines feed the top ply as well as the bottom one. This prevents plyshifting and twisting of the fabric being sewn, generally enhancing the visual characteristics and textures of the material, without any lose of the original properties of the fabric on sewn products.



Point 2 Neat performance of shirring and piping

The top and bottom feed dogs are independently driven. Large differential feed ratios can be obtained. These features increase feeding efficiency. Especially, shirring is effectively performed.

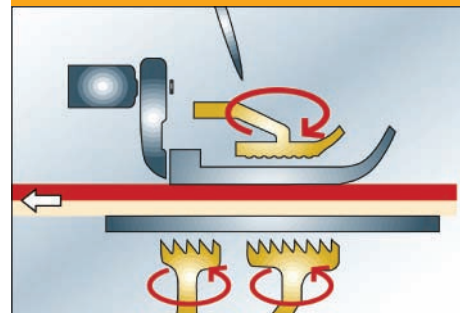

Point 3 Prevention of puckering

The stopper regulates the path of the top feed dog just before it contacts the bottom one. Thanks to this feature, no wrinkle is produced on the fabric during sewing with increased feeding distance. Thus, variable top feed machines prevent puckering.

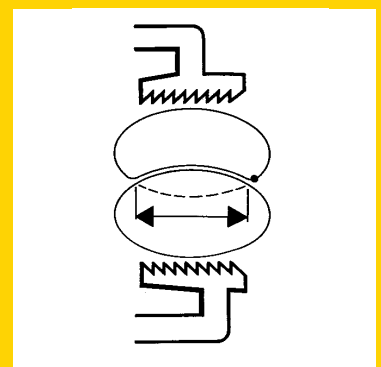

Point 4 Beautifully finished products with balloon stitches

The up-and-down stroke of the top feed dog can be selected as desired according to the fabric and operation being employed. Large and strong strokes are used for sewing heavy weight fabrics and/or cross seam sections, and small strokes with soft touch are employed for sewing light weight fabrics.

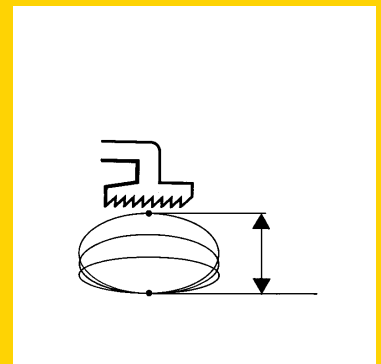

Other Features

■ Feeding is assured even with heavy weight fabrics

On safety stitch machines, a combination of double chainstitch thread take-ups and needle plates produces beautiful and soft stitches, called balloon stitches.

■ Easy-to-adjust top and bottom feed dogs for the fabric employed

The front-to-back movement of the top feed dog can be easily adjusted from the outside. Three kinds of adjustments are available, rear-fixed, divided-in-half and front-fixed adjustments. The rear fixed type is used to obtain beautiful shirring, and the front fixed type is employed for effortlessly riding out cross seam sections.

■ All subclasses equipped with upper and lower Needle/Thread cooler devices (HR) that protect the fabrics and threads against heat.

Heat is generated on the needle due to friction when the needle penetrates the fabric at high speeds. This causes thread breakage and/or stitch skipping. This series is equipped with HR device that always prevents heat generation on the point of the needle, allowing the thread to move smoothly and producing the stitches uniformly.

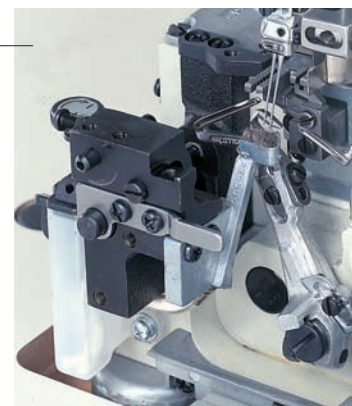
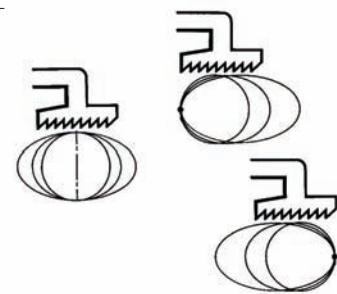
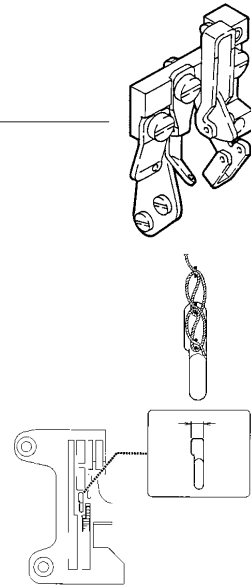

EXT Devices

■ Tape/Thread chain cutter (TK/AT)

Devices that trim the tape and/or thread chain when sewing is completed. Eliminates for the need for cutting the tape and/or thread chain by hand, such as using scissors. Two types are available.

There are two types of driving methods available, pneumatic and electric.

Manual type:TK

Switch operated device that cuts the tape and/or thread chain. Pressing the switch brings the knife down to cut the tape and/or thread chain. Two types of switches are available.

Electric type of finger switch

Pneumatic type of knee switch

Automatic type : AT

The sensor detects the fabric edge to trim the tape. This device includes the controller that regulates the length to be trimmed by stitch counting.



■ Thread chain cutter (KS/KH)

Device that cuts the thread chain and disposes of it through vacuum suction. Eliminates for the need for cutting the thread chain by hand, such as using scissors. Two types are available.

Vertical type vacuum chain cutter : KS

The suction inlet is positioned vertically to the cloth plate.

Flat type vacuum chain cutter : KH

The suction inlet is positioned flush with the cloth plate.





EXT Series Subclasses

Variable top feed, safety stitch machines: EXT3200

Seam	Type of machine	Model	No. of needles	No. of threads	Machine speed(rpm)	Remarks
Plain seaming						
① ②	Plain seaming light to medium weight fabrics, such as dress shirts, blouse	EXT3216(15)-02/223	2	5 (4)	7,000	
① ②	Plain seaming medium to heavy weight fabrics, such as pajamas	EXT3216(15)-03/233	2	5 (4)	7,000	
①	Plain seaming medium to heavy weight fabrics, such as casual shirts	EXT3216-03/333	2	5	6,700	
① ③ ④ ⑩	3-needle machines for plain seaming cotton pants and similar garments with wide seam	EXT3244-03/333	3	6	6,700	
① ②	Plain seaming medium weight fabrics, such as light weight denim, cotton pants	EXT3216(15)-03/433	2	5 (4)	6,300	
① ②	Plain seaming heavy to extra heavy weight fabrics, such as jeans	EXT3216(15)-A04/435K	2	5 (4)	6,300	with wide angled knife
① ③ ④ ⑩	3-needle machines for plain seaming medium to heavy weight fabrics, such as casual pants	EXT3244-A04/435K	3	6	6,300	with wide angled knife
① ②	Plain seaming heavy to extra heavy weight fabrics, such as jeans, working wear	EXT3216(15)-B-04/435K	2	5 (4)	6,300	
① ②	Plain seaming extra heavy weight fabrics, such as jeans	EXT3216(15)H-A05/535K	2	5 (4)	5,500	with wide angled knife
Shirring						
① ③	Shirring light to medium weight fabrics, such as apron, children's wear	EXT3216(15)-42/233	2	5 (4)	5,500	with shirring device
Shirring piping						
③	Shirring piping extra heavy weight fabrics, such as bed cover	EXT3216H-45P1/574K	2	5	5,500	with shirring device
Piping						
⑦ ⑧	Piping medium to heavy weight fabrics, such as training wear	EXT3216(15)-C3P1/233	2	5 (4)	6,700	
		EXT3216(15)-C3P2/233	2	5 (4)	6,700	with binder (25mm)
⑦	Piping extra heavy weight fabrics, such as sofa	EXT3216H-C5P1/574K	2	5	5,500	

Variable top feed, overedgers: EXT5200

Seam	Type of machine	Model	No. of needles	No. of threads	Machine speed(rpm)	Remarks
Plain seaming						
③	Plain seaming light to medium weight fabrics, such as T-shirts	EXT5204-02/233	1	3	7,000	
③ ⑩	Plain seaming medium to heavy weight fabrics, such as polo shirts, jersey	EXT5214-03/333	2	4	6,700	
		EXT5214-M03/333	2	4	6,700	
Blindstitch hemming						
①	Blindstitch hemming light to medium weight fabrics, such as T-shirts	EXT5205-12/223	1	3	5,500	with blindstitch hemming guide(40mm)
Shirring						
⑫	Shirring medium to heavy weight fabrics, such as pillowcase, aplan	EXT5214-43/333	2	4	5,500	With shirring device
Attaching tape						
⑮	Attaching tape heavy to extra heavy weight fabrics, such as training wear, sweat shirts	EXT5214-54S1/433	2	4	6,300	with a set of parts for attaching tape
		EXT5214-54S2/433	2	4	6,300	with a set of parts for attaching tape, shirring device
⑮	Attaching tape heavy to extra heavy weight fabrics, such as sweater	EXT5214-54S1/443	2	4	6,300	with a set of parts for attaching tape
		EXT5214-54S2/443	2	4	6,300	with a set of parts for attaching tape, shirring device
⑮	Attaching tape extra heavy weight fabrics, such as bulky sweater	EXT5214H-55/545	2	4	5,500	with a set of parts for attaching tape, wide knife
Backlatching						
⑭	Backlatching heavy to extra heavy weight fabrics, such as sweater	EXT5214-84/433	2	4	6,300	
⑭	Backlatching heavy to extra heavy weight fabrics, such as bulky sweater	EXT5214H-85/535K	2	4	5,500	for BT250A
Piping						
⑮	Piping medium to heavy weight fabrics, such as training wear	EXT5214-C3P1/333	2	4	6,700	
		EXT5214-C3P2/333	2	4	6,700	with binder(20mm)

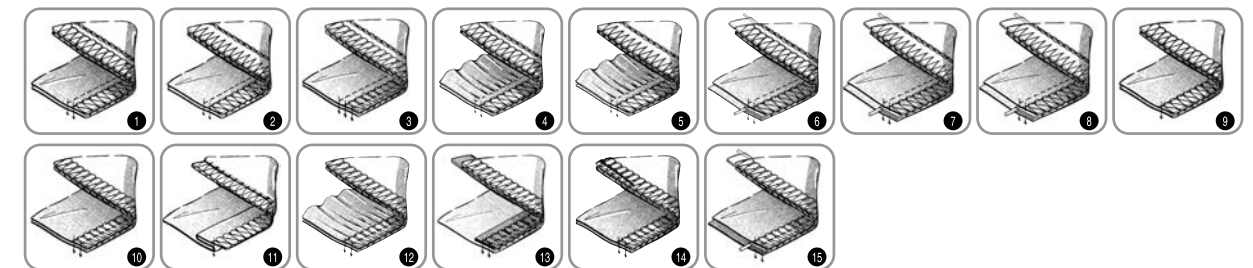

PEGASUS SEWING MACHINE MFG.CO.,LTD.
 5-7-2, Sagisu, Fukushima-ku, Osaka 553-0002, Japan
 Phone: 81-6-6458-4739 Telefax: 81-6-6454-8785
<http://www.pegasus.co.jp>

※The specification and/or appearances of the equipment described in this catalog is subject to change because of modification without previous notice.

Backlatching device (BT)

Device that backlatches the thread chain by sewing it back into the seams on the fabric at the start of sewing. Eliminates the need for a bartacker and the operator, reducing time and dramatically increasing efficiency.



Intermittent shirring device (KL)

Can easily perform a shirring or a fullness operation partially. Three types of driving methods (manual, electric and pneumatic) are available.

Lint collector (LC)

Powerfully collects thread chains and cutting waste by compressed air. The waste is sucked into an easy to handle collector is compact, so it saves space in the factory.

Presser foot lift (PL)

Reduces operator fatigue. Pressing the treadle actuates the air cylinder to raise the presser foot.

